



MASTER

ROMAN

PRACTICE SHEETS

# Welcome

Hey! Glad you could make it. Welcome to your new skill, hobby or script. I promise that after completing this workbook once through, you will be well-versed in the structure of letters and how to make your own calligraphy compositions.

These are the topics that start basic and get more advanced as we go:

## Table of Contents

---

- 2. Welcome & Table of Contents
- 3. Tools You'll Need
- 4. Introduction to Blackletter Calligraphy
- 5. Blackletter Legend
- 6. Basic & Advanced Strokes
- 8. Roman Introduction
- 9. Roman Letters
- 18. Roman Words
- 22. Flourishing
- 24. Composition
- 26. Certificate

---

If that sounds like too much, don't worry, I'll walk you through it. As always work at a pace that works for you. The only thing I will stress is to keep at it and don't give up. Try your best to be consistent in making time to practice. That will be the key to your success.

Let's GO



## Tools You'll Need

Tools you will need to work through these practice sheets:



### 1. Broad edge pen

There are 2 types of broad edge pen: one where you dip after every few strokes, and one writes until the ink cartridge runs out. These sheets have been designed for a 6mm (blue tip) Pilot Parallel pen. Most broad edge dip pens typically do not have a 6mm tip.

Recommendations: A. Pilot Parallel 6mm - <https://amzn.to/3eHk6f5>  
B. Broad Edge Dip Pen- <https://amzn.to/3qxqLht>

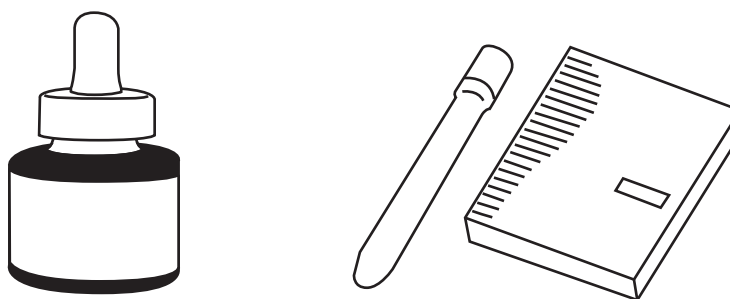

### 2. Ink

The ink that comes with the Pilot Parallel can work but it can make your paper slightly "bleed" (look a bit fuzzy) depending on the colour. If you want crisper lines, and a lot more ink, try the liquid watercolour.

Recommendations: A. Ecoline Liquid Watercolour - <https://amzn.to/32W2JVb>  
B. Pilot Parallel Cartridges - <https://amzn.to/3eHjjeF>

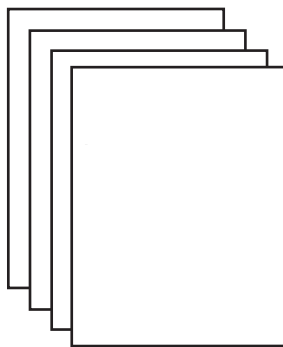

### 3. Paper

Normal printer paper has a lower paper density and may cause problems with your ink. High quality paper is necessary to get crisp hairlines and minimize ink bleeding. Recommendation "B" offers texture to your paper allowing your writing to look "weathered." However, it's best to start off with the option "A".

Recommendations: A. HP Premium Choice (Density: 32lbs/120gsm) - <https://amzn.to/3fgORXA>  
B. Southworth Business Paper (Density: 32 lbs/120gsm) - <https://amzn.to/2YgL9qO>

What is

# Blackletter?

Blackletter, also referred to as Gothic, is an umbrella term for calligraphy scripts created with a broad edge pen. Derived from the latin alphabet, these scripts were commonly used in the 12th to 17th century for Western and Northern European languages.



Examples include: Fraktur, Textura, Batarde, & Rotunda.

## What is a Broad Edge Pen?



Downstrokes (Thick)

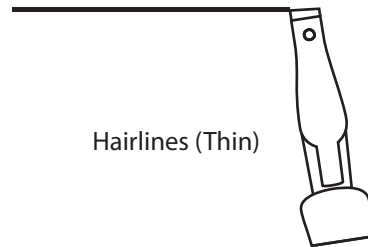

Hairlines (Thin)

A Broad Edge Pen is a writing instrument with a wide head but a thin edge. This allows 2 dominant thicknesses of strokes: downstrokes and hairlines. Some examples of broad edge tools are cartridge pens, dip pens, chisel tip markers and highlighters.

## Setting up your Pilot Parallel

1. Unscrew the handle and remove it.

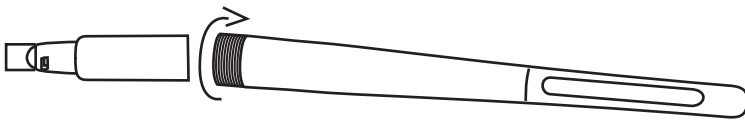

2. Insert Pilot Parallel cartridge\* and replace handle.



3. Keep making strokes onto paper until ink flows.

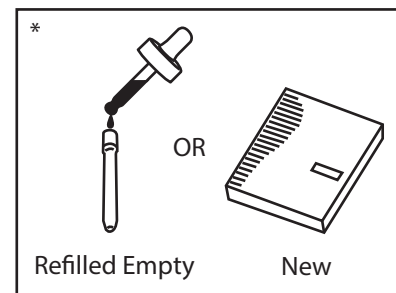
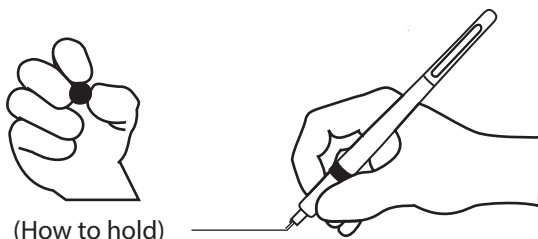

# Blackletter Legend

For each alphabet, there are symbols on their respective introduction page that give you some information about the script. This page is a detailed explanation on how to use them, but also teach fundamental techniques and terms of blackletter scripts.



Pen angle refers to what angle your nib makes with the baseline (the horizontal line you write on). There will be two ways of representing the letters, depending on the script, to help you learn how to complete each stroke:

## 1. Pen Angle

While maintaining pen angle, start at the dot (●) and follow the dotted path to the end of the arrow.

Alphabets with fixed pen angle

Constant Angle

Start at the dot (●) at the angle indicated by the line. Follow the lines and adjust the pen angle to each line as you come to it.

Alphabets with the "twisting" advanced technique 7.

Angle

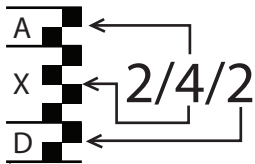

Letter height refers to the height of the letter, measured in nib widths. There are three numbers: Ascender, X-Height & Descender (Notated by A/X/D).

## 2. Letter Height

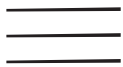
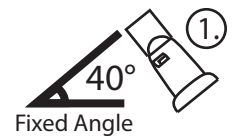
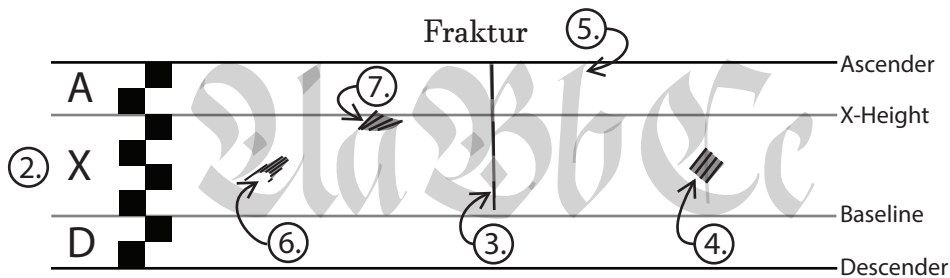

## 3. Hairlines

Hairlines are the thinnest stroke, completed 1 of 2 ways:

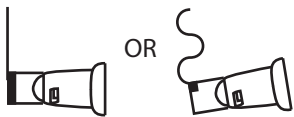

## 4. Quads

Quads are small decorative flourishes that are diamond shaped.



## 5. Serifs

Serifs are the shape that tops each ascending stroke.

### Advanced Techniques

## 6. Tilting

Tilting is a technique to thin strokes without altering angle. It is performed by adjusting the pen nib's surface area touching the paper by tilting the pen.

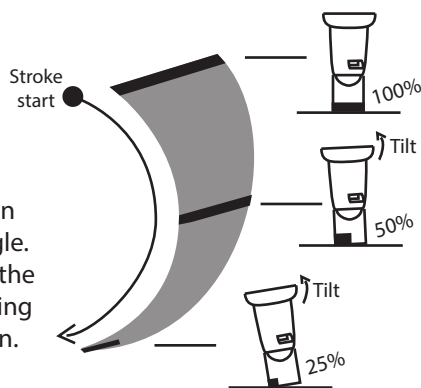

## 7. Twisting

Twisting is a technique to thin strokes without adjusting surface area. It is performed by adjusting the pen angle by twisting it with the middle finger and thumb.

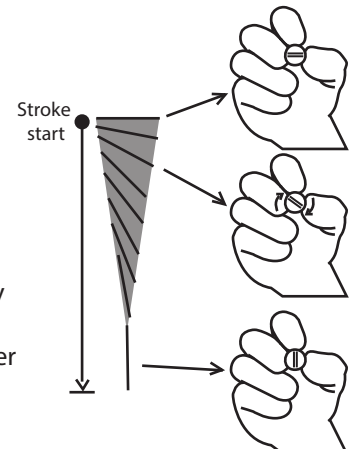

Basic Strokes  
Quads

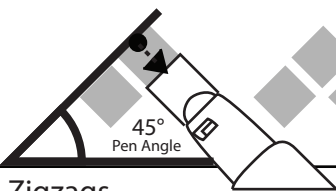
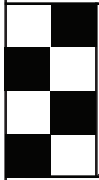

Zigzags

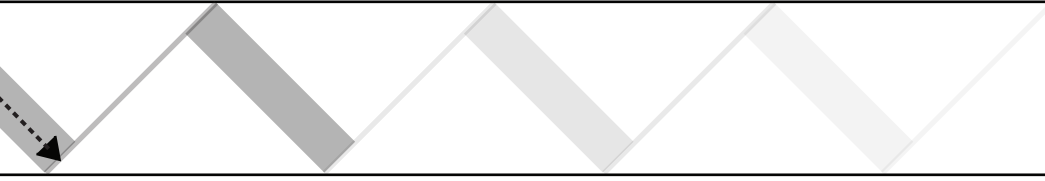
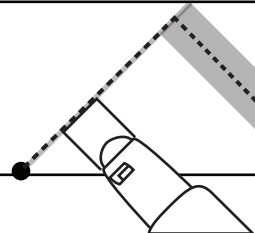
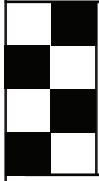

Oh's

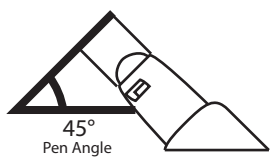
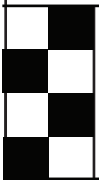

30° Compound Stroke

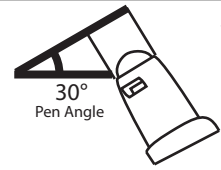
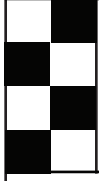

45° Compound Stroke

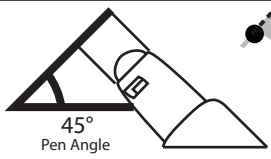
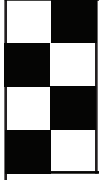

Swivel

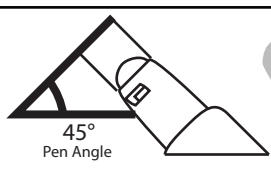
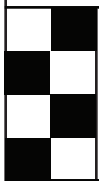

'C' Curve

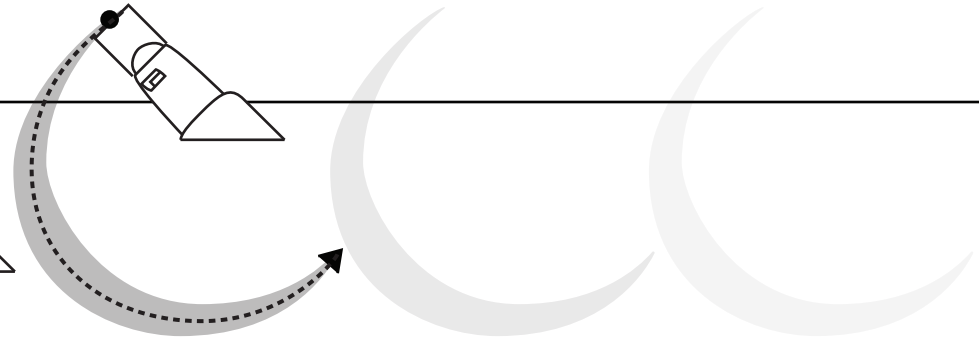
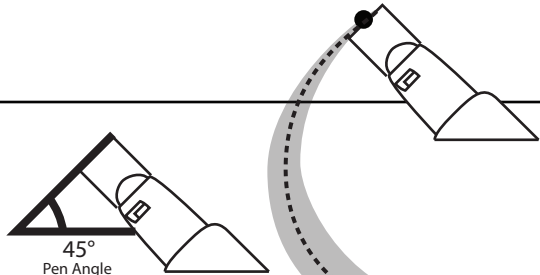
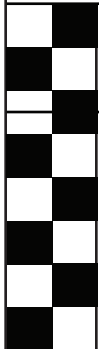

Advanced Strokes

Down Twist

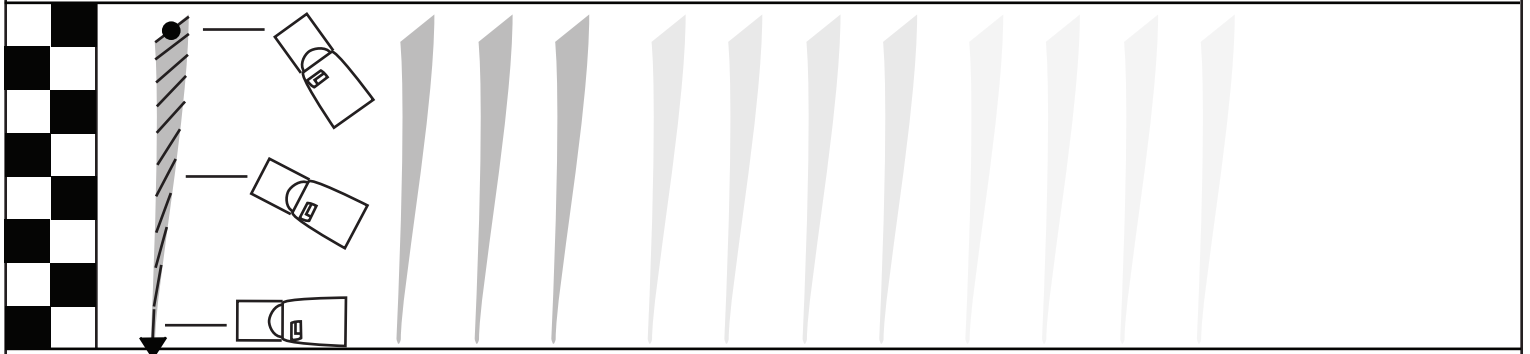

Side Twist



Single Tilt

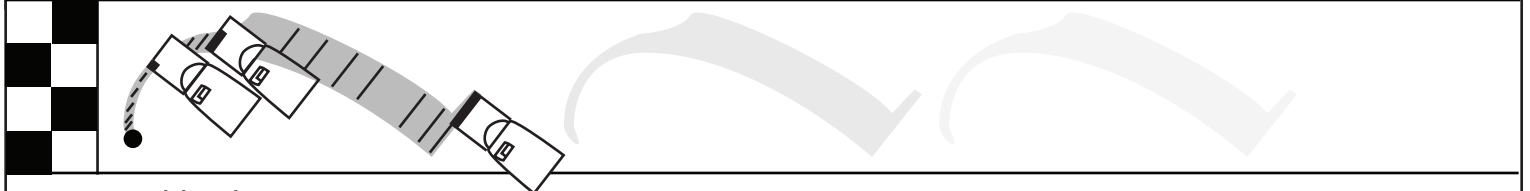

Double Tilt

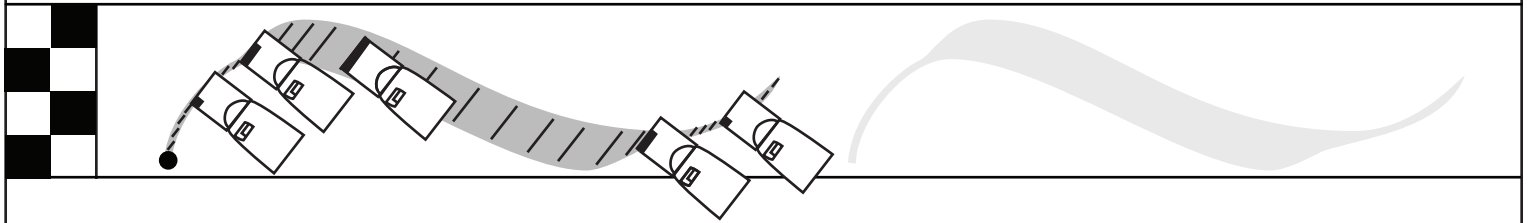

Tilt then Twist



Twist then tilt



# ROMAN



Country of Origin: Roman Empire  
Date Used: 1st-5th century

A B C D E F G H I J K L

M N O P Q R S T U

V W X Y Z

THE QUICK BROWN  
FOX JUMPS OVER THE  
LAZY DOG

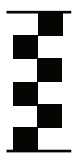

0/6/0

Height



Varied Angles



Twisting

ABC

Majuscular



Serif

Check out the Legend (Pg 4) for further explanation on above symbols.



Roman Alphabet - "A" - "C"

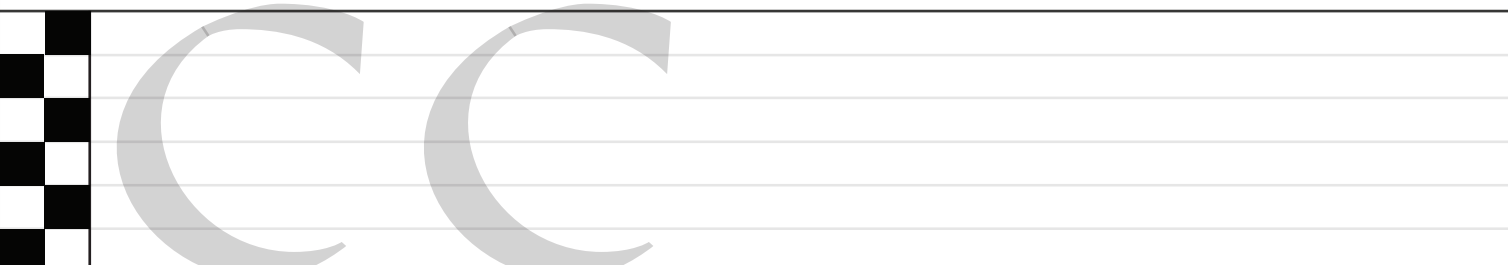
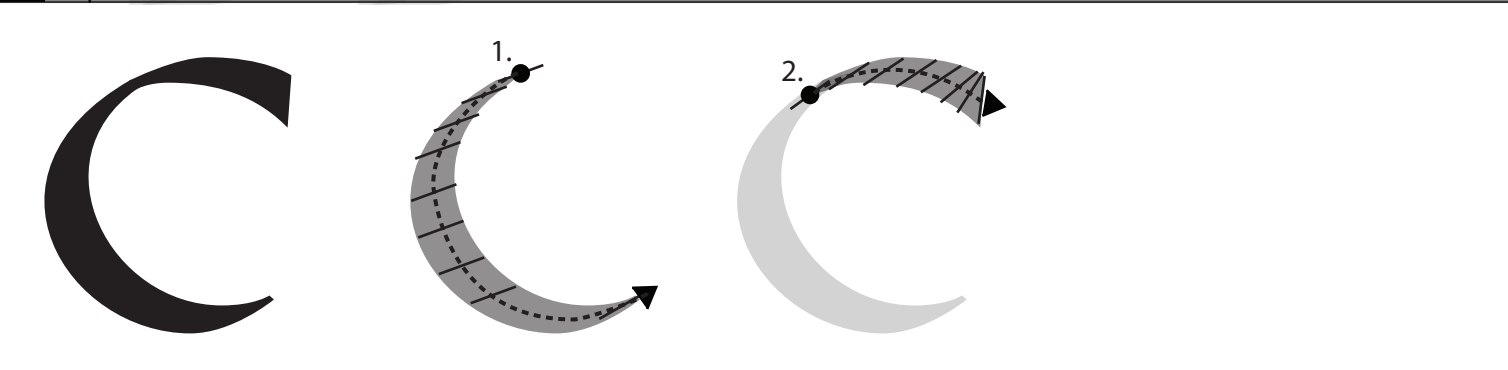
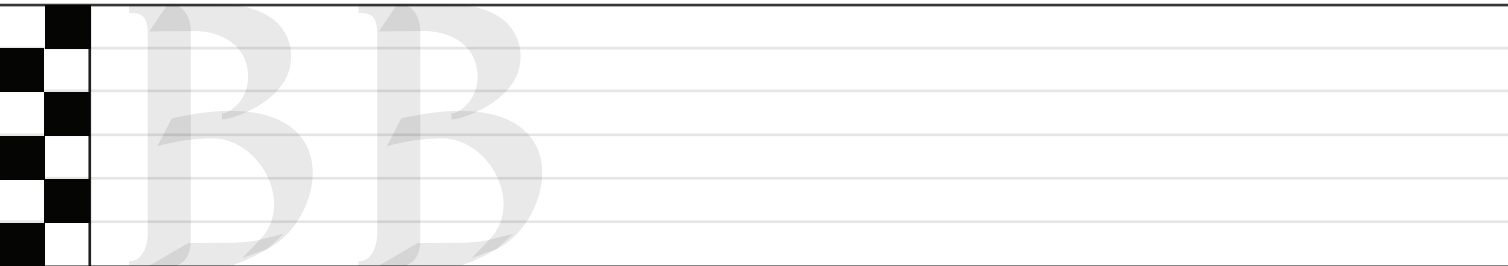
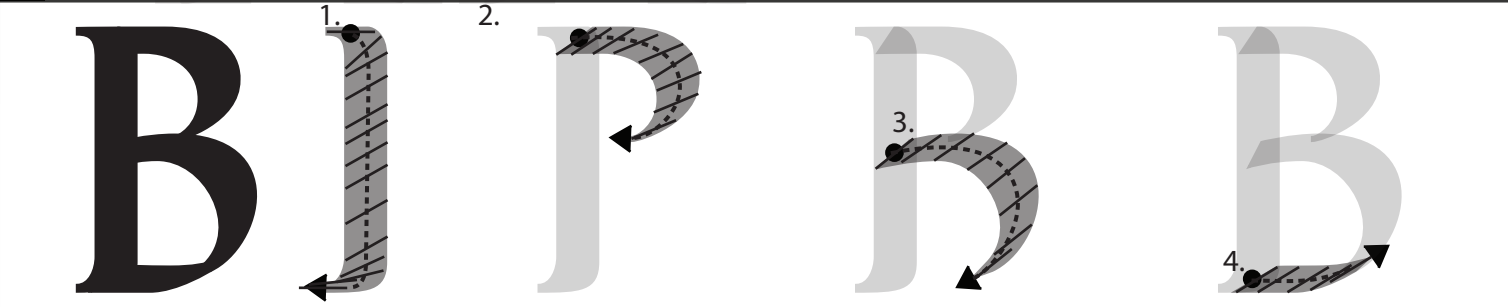
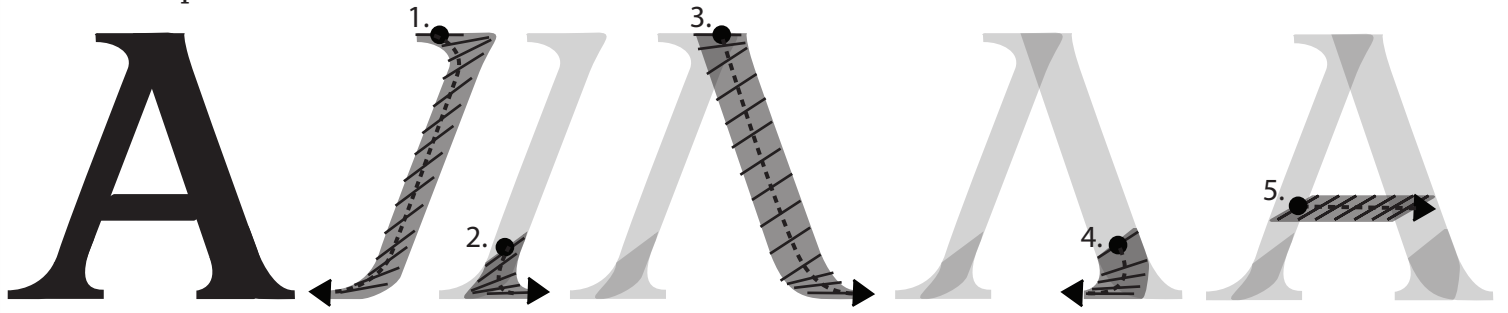

Roman Alphabet - "D" - "F"

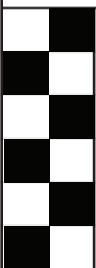
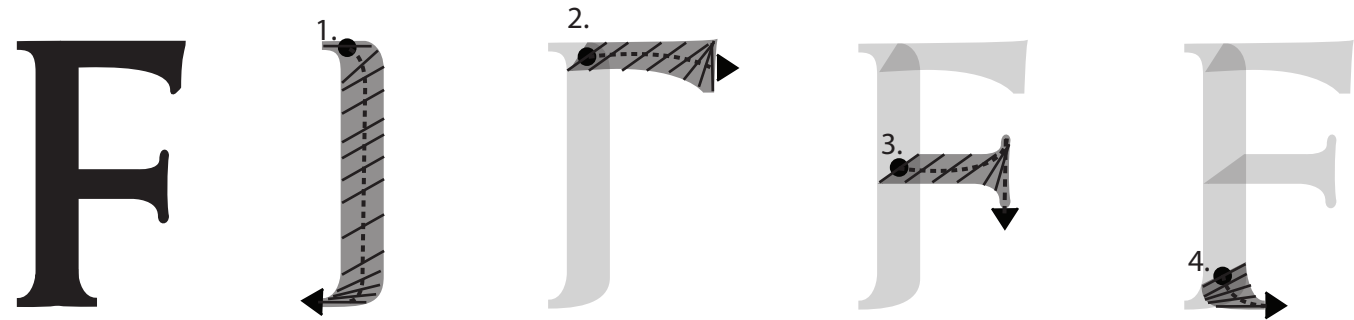
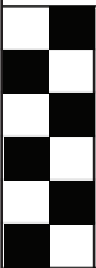
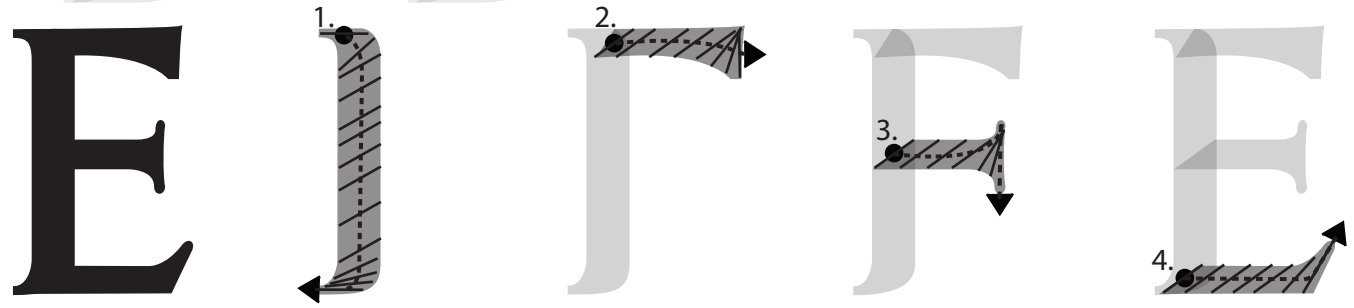
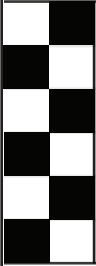
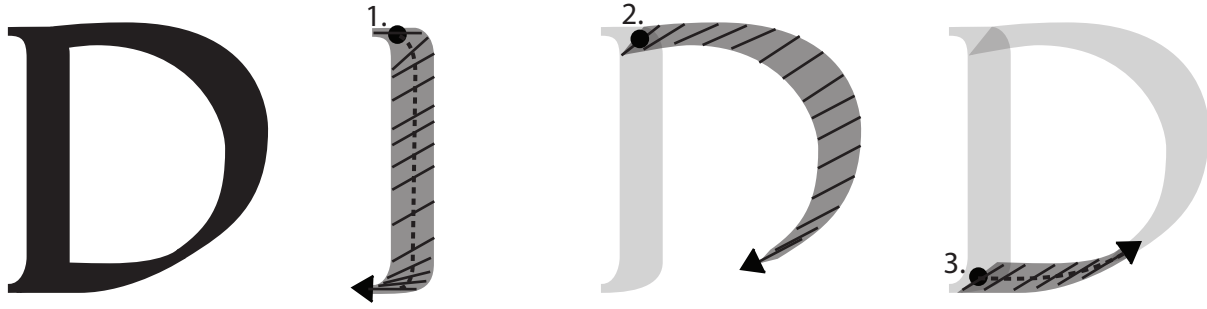

Roman Alphabet - "G" - "I"

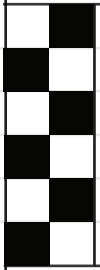
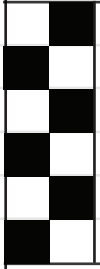
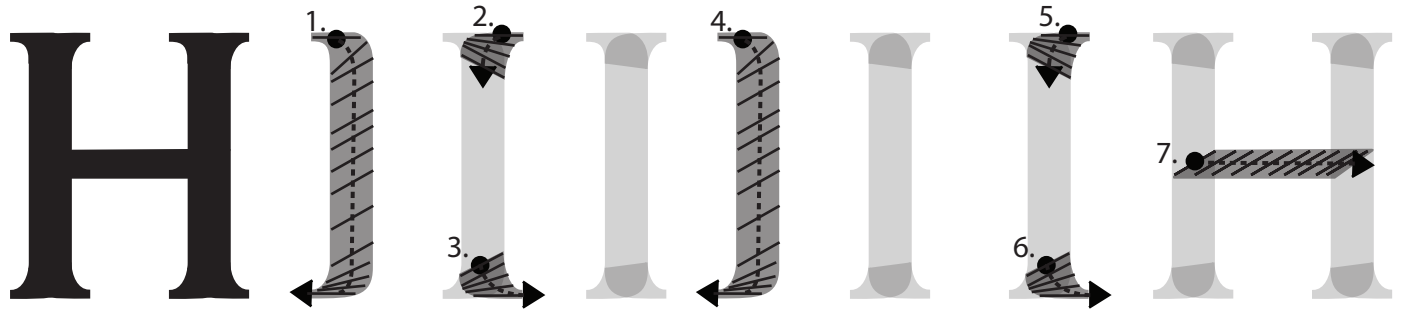
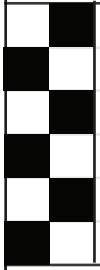
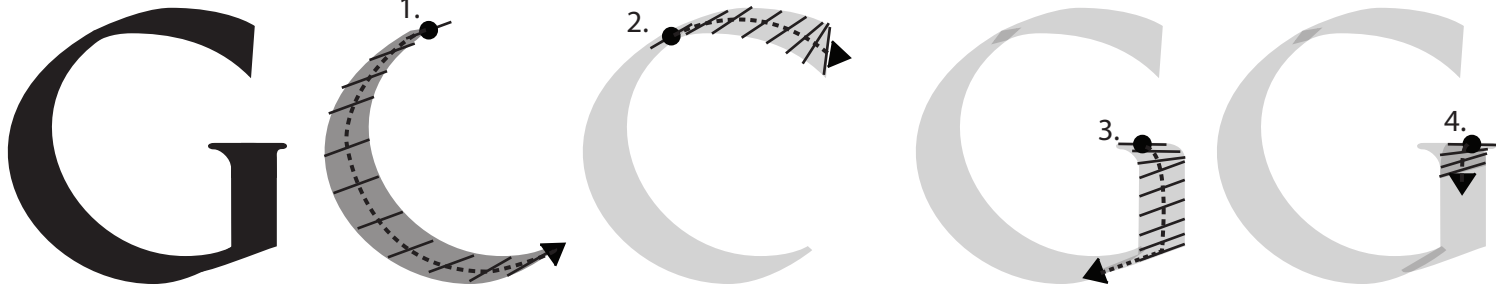

Roman Alphabet - "J" - "L"

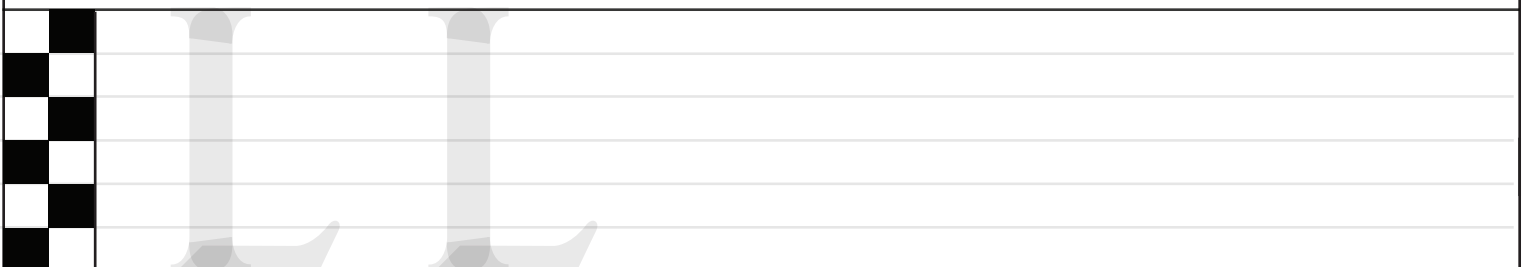
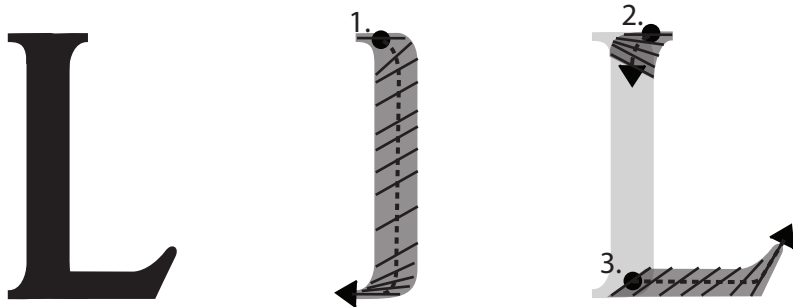
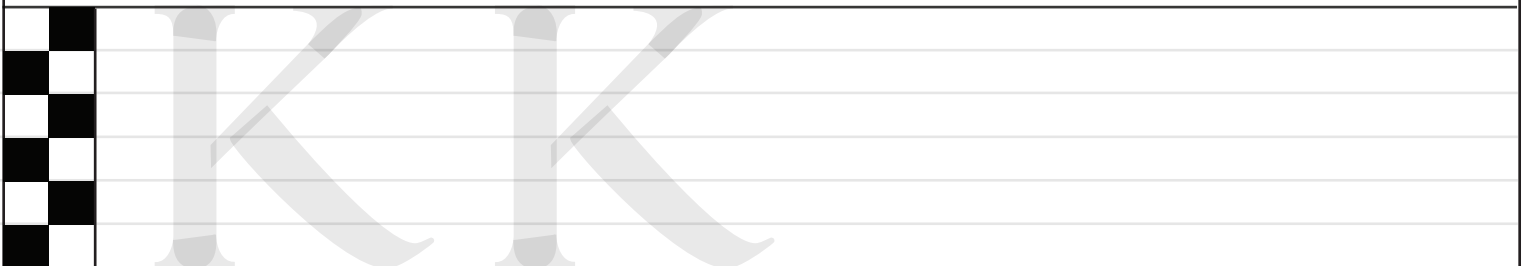
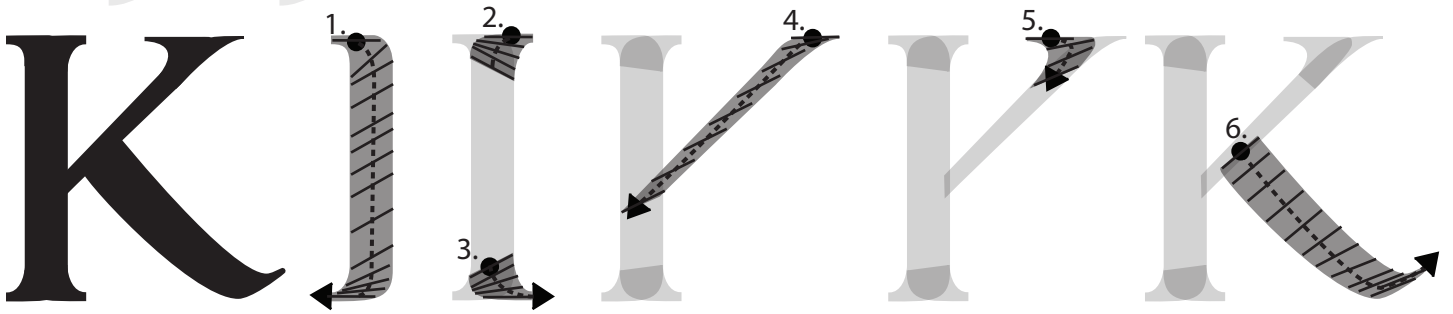
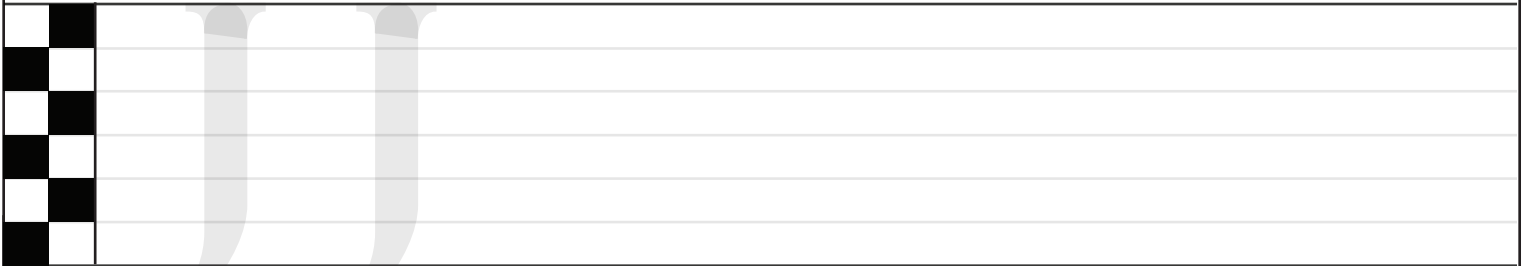
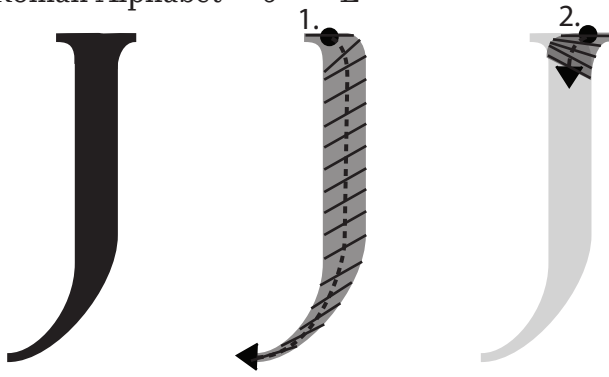

Roman Alphabet - "M" - "O"

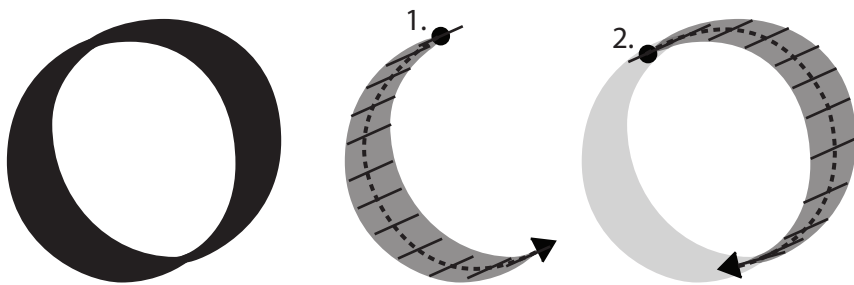
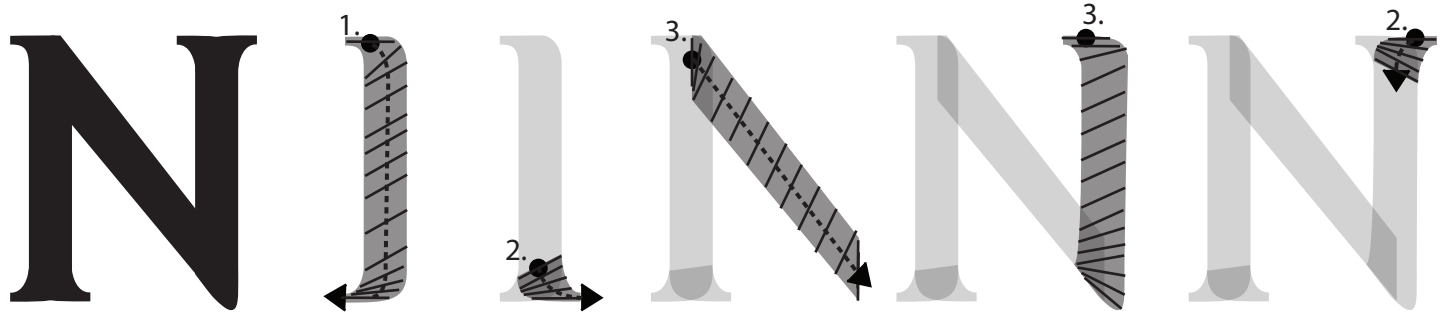
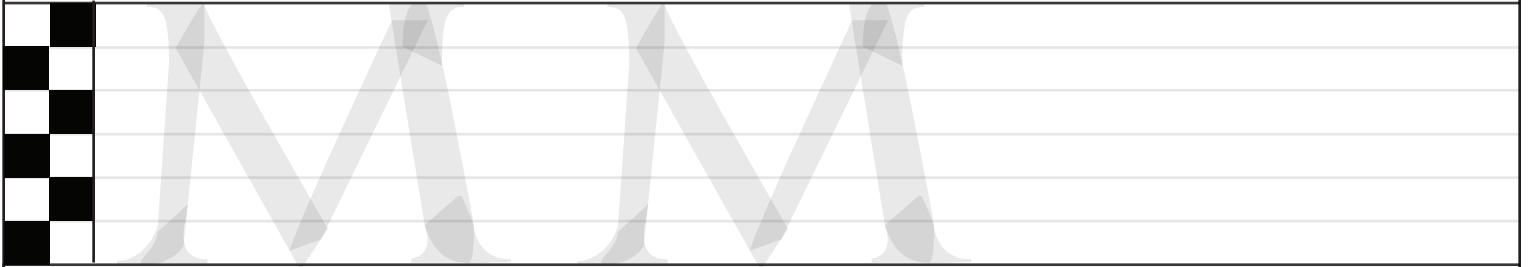
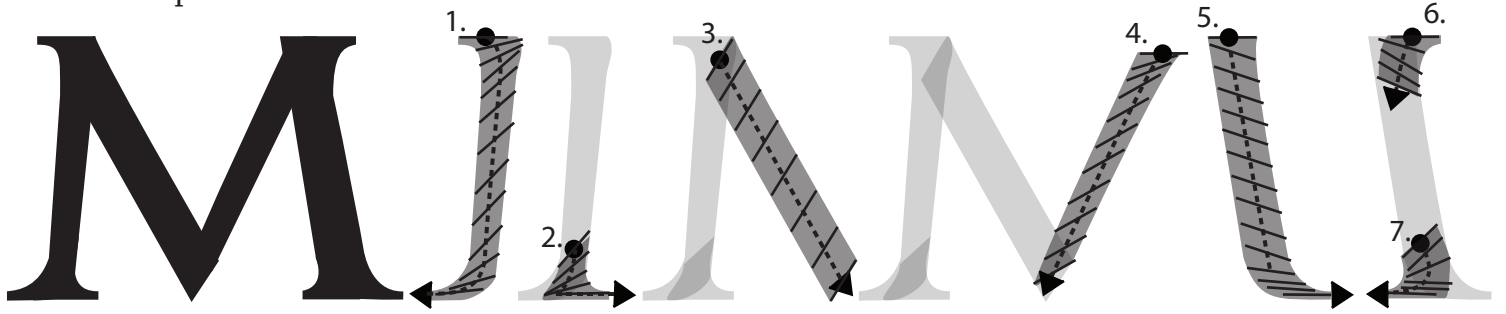

Roman Alphabet - "P" - "R"

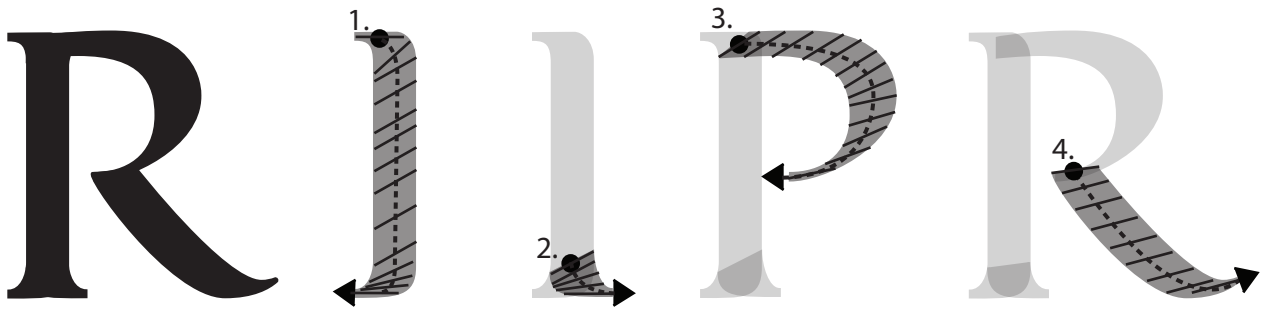
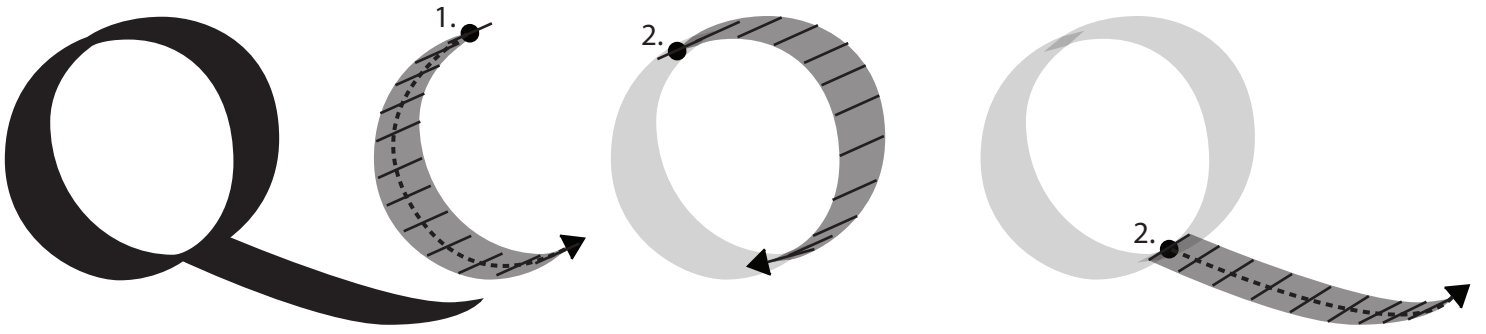
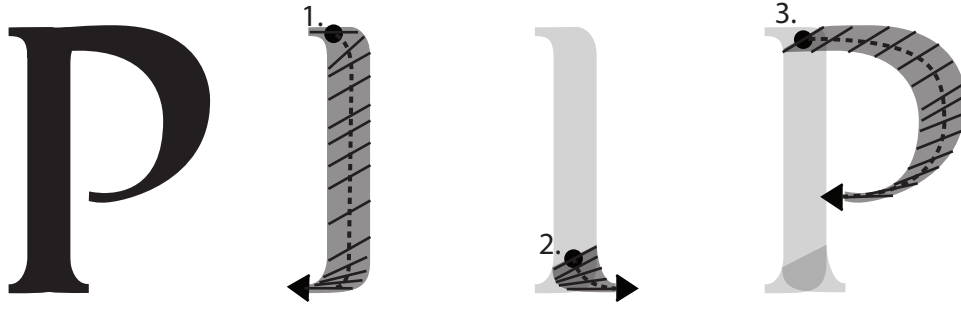

Roman Alphabet - "S" - "U"

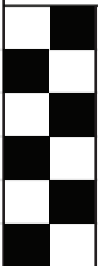
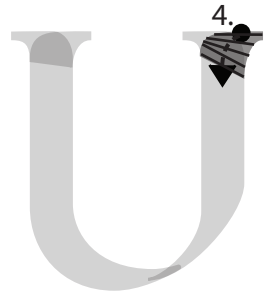
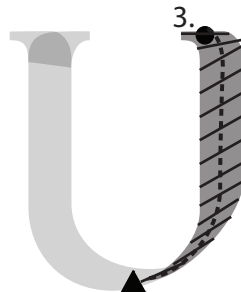
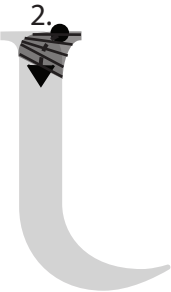
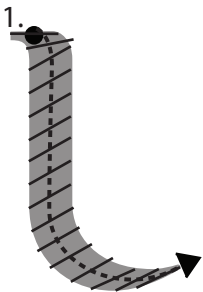
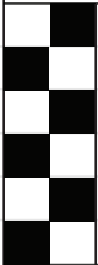
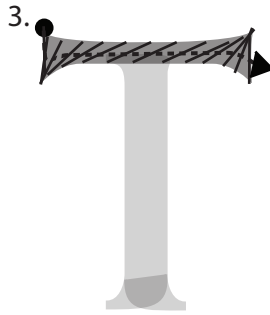
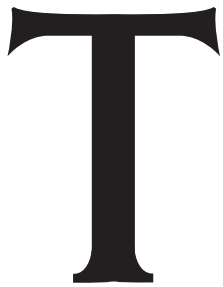
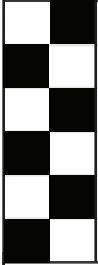
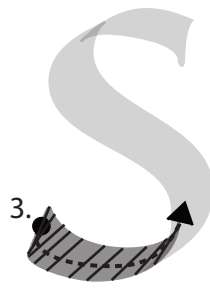
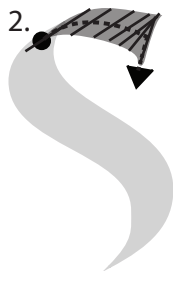
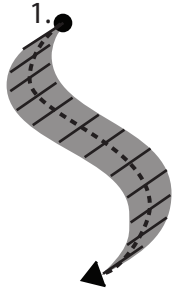

Roman Alphabet - "V" - "X"

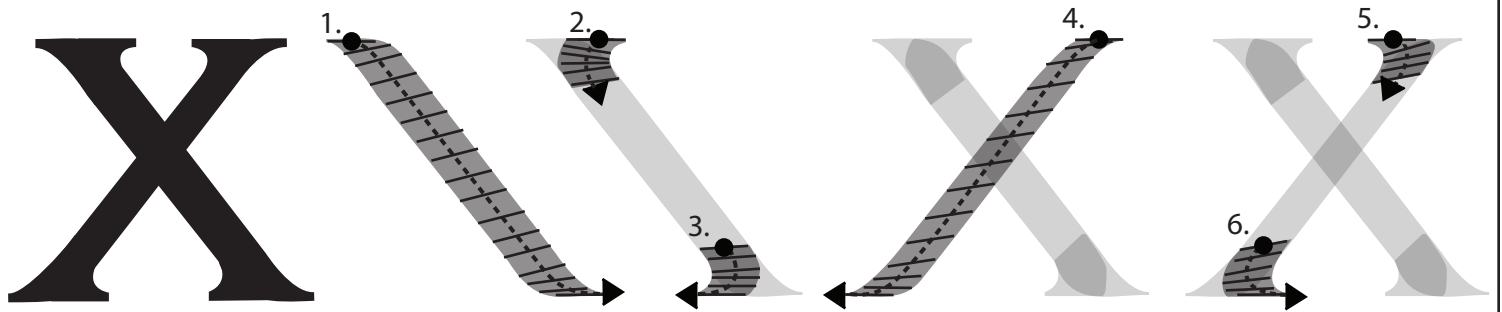
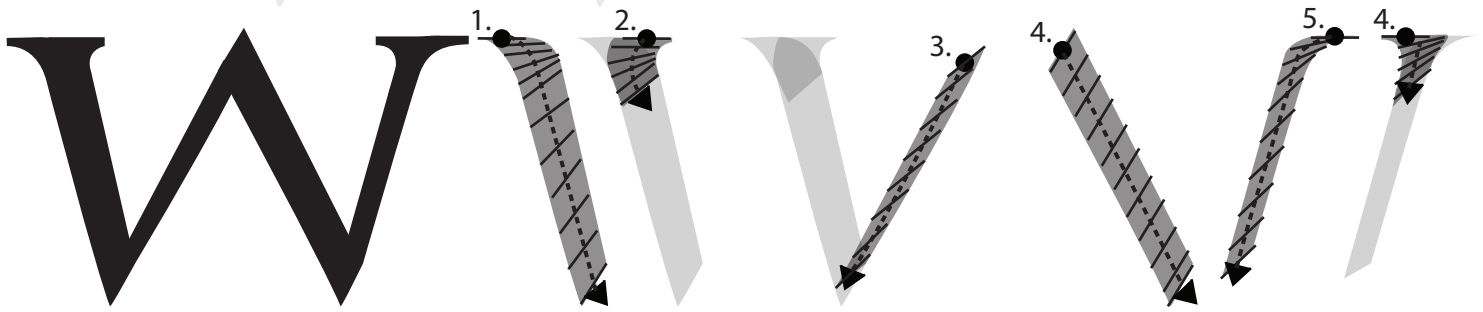
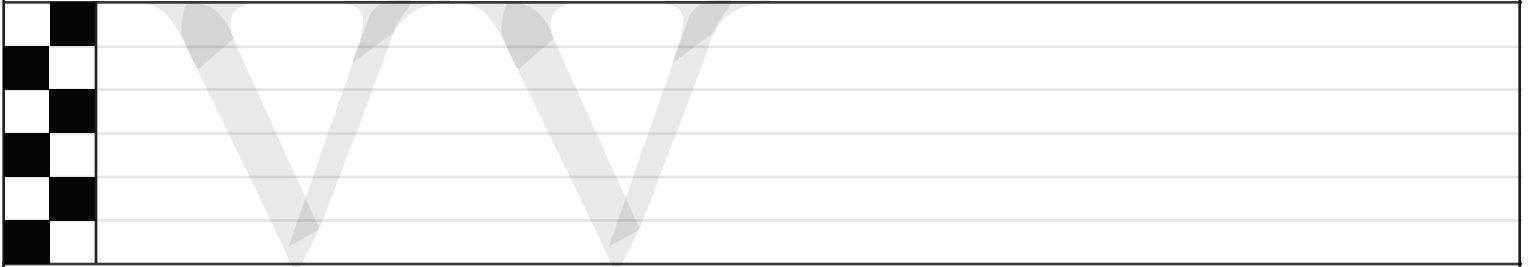
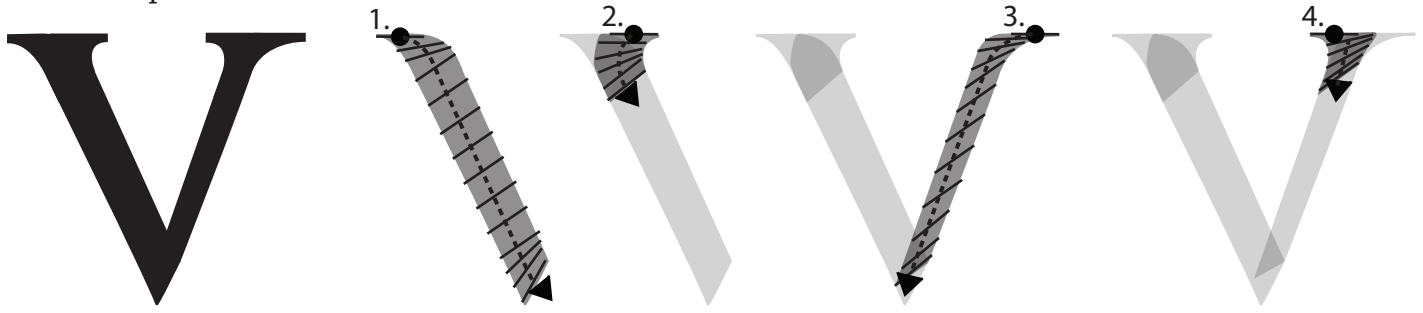



Roman Alphabet - "Y" - "Z"

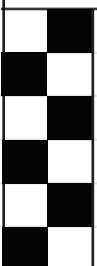
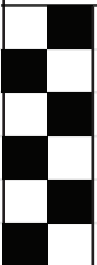
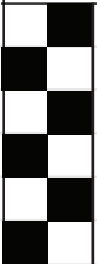
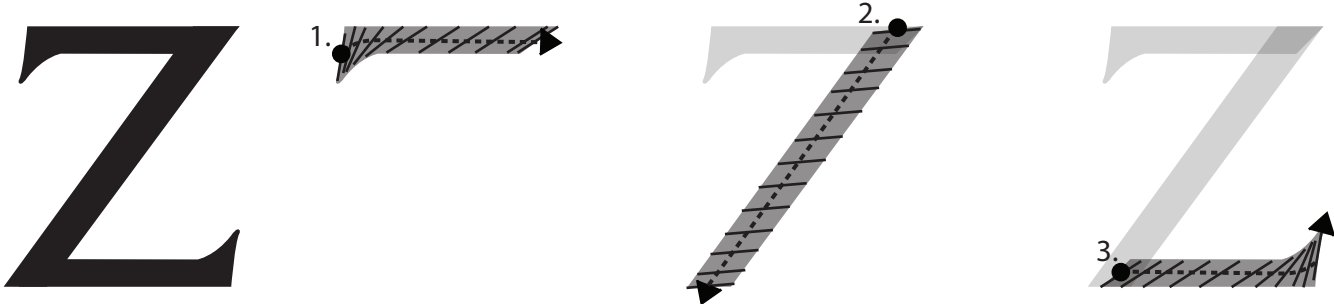
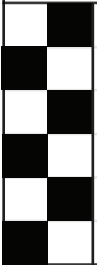
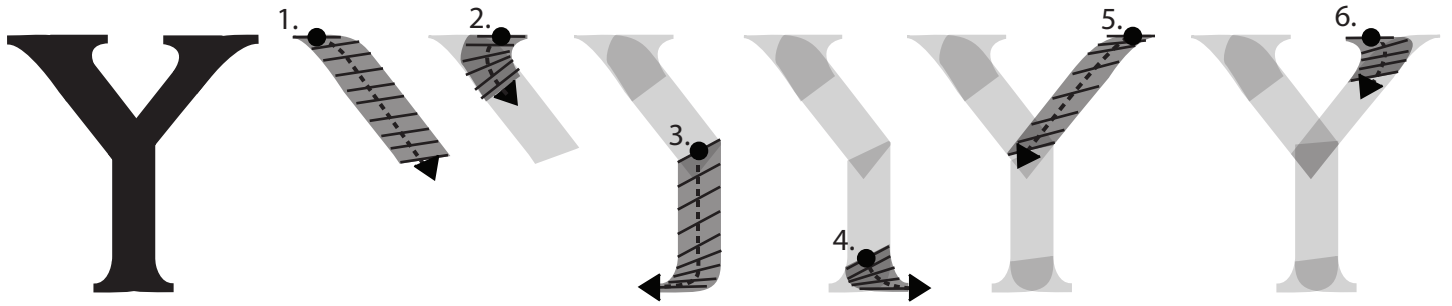

THE

Word Spacing

QUICK

BROWN

FOX

JUMPS

OVER

THE

Word Spacing

LAZY

DOG

Roman Alphabet - Open Practice

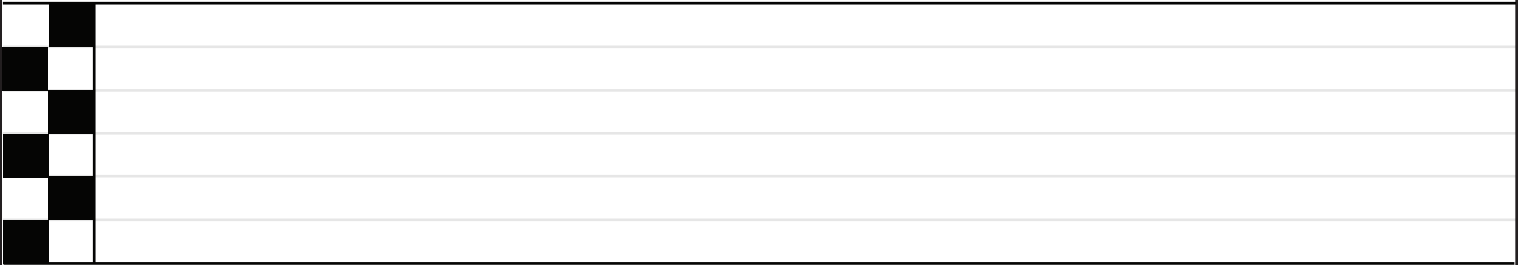
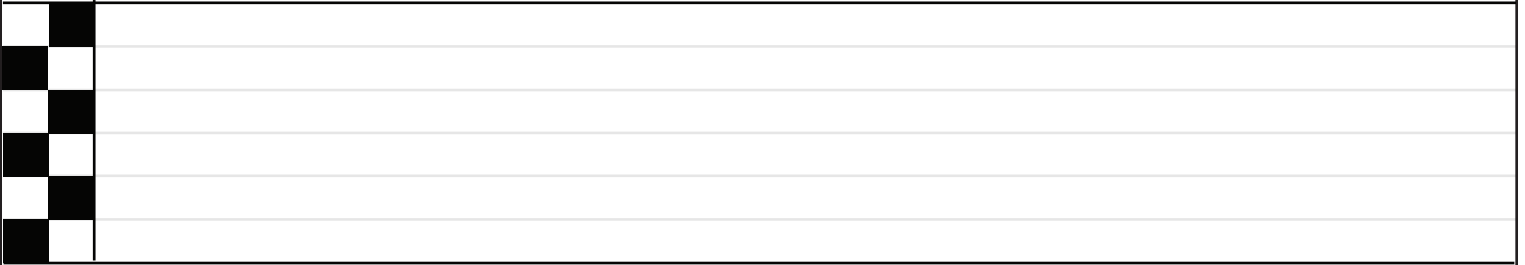
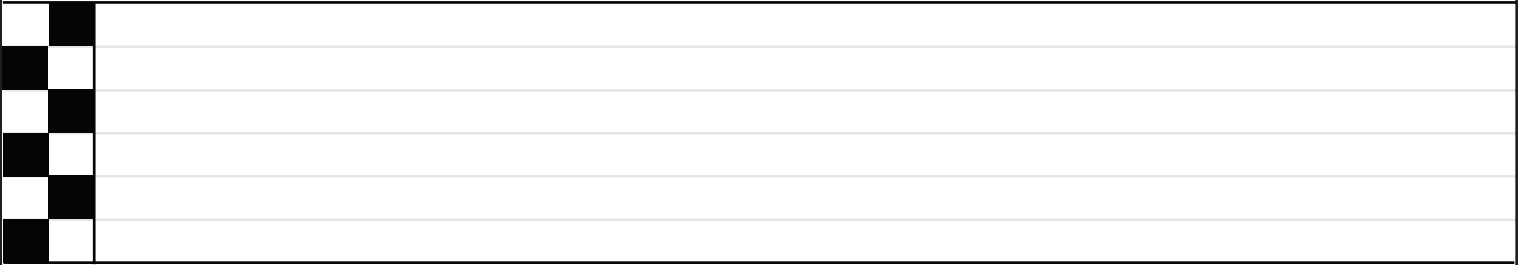
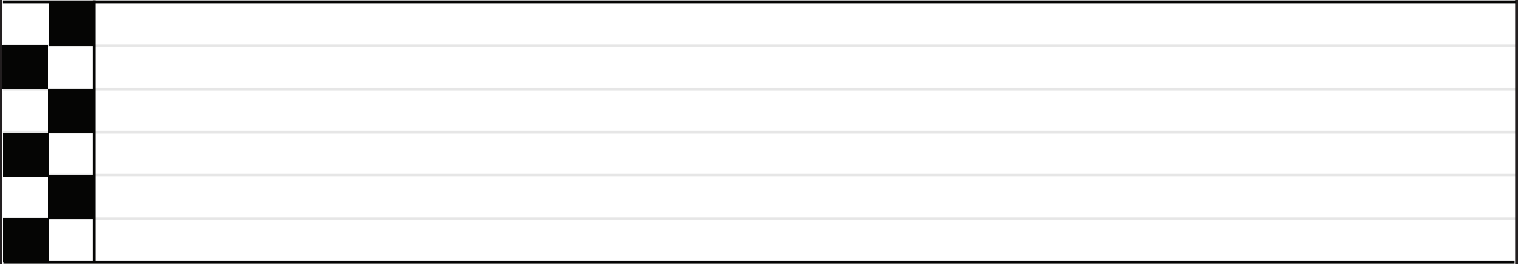
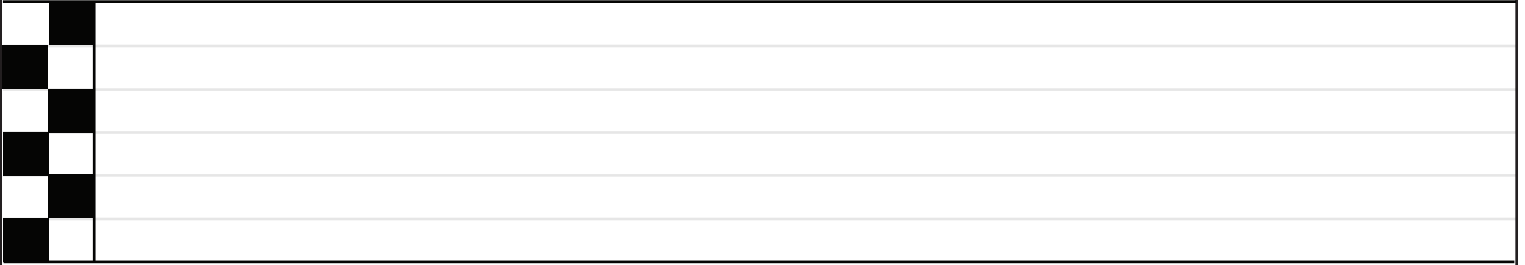
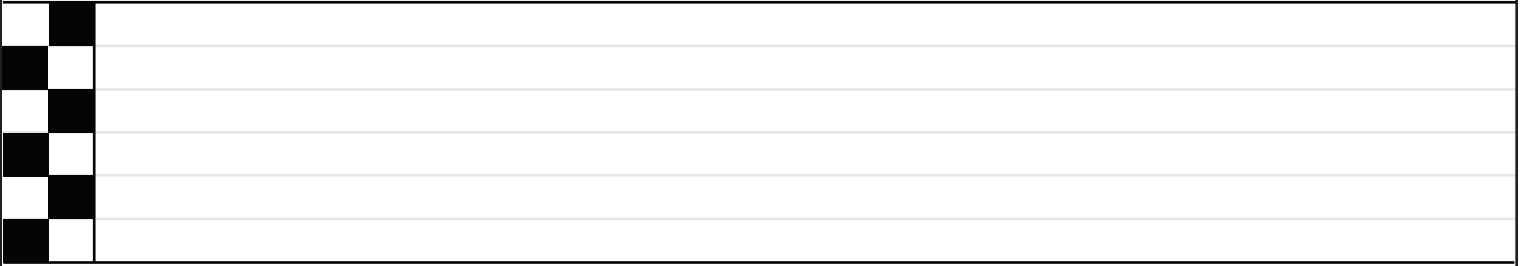

### What are flourishes?

A flourish in calligraphy is an ornamental flowing stroke that adds to calligraphic letters to beautify a composition. There are two main types: Letter flourishes that extend from existing letters, and abstract flourishes that are independent from the letters. They can be as simple as adding ornamental ends to your upstrokes to multi-stroke abstract flourishes.



Letter Flourish



Abstract Flourish

### Where do I flourish?

There are 4 main places where you would want to flourish.

#### 1. Beginning and end of a word or sentence

Capitals are naturally decorative but you can change it up. This kind of "frames" the letters.



#### 2. Ascenders and Descenders

Instead of looping into itself, or the next letter additional loops are added.

#### 3. Get creative! Extend a section of a letter and flourish off that!\*

\*Careful with letter clarity.  
For example, you could extend an "a" into a "d"

# Flourishing: The 5 Guidelines of Flourishing

What are the rules?

There are no hard and fast rules to flourishing. However, I have compiled 5 guidelines for you to follow to create aesthetically pleasing flourishes. At the bottom of the page, you will a composition that follows all of them.

## The 5 Guidelines of Flourishing

### 1. Thickness

Strokes can cross one another if they are 2 of the 3 possibilities listed to the right



Downstrokes can cross Hairlines.  
Hairlines can cross Hairlines.



Downstrokes CANNOT cross downstrokes.



### 2. Angle

When penstrokes cross, the closer the lines are to perpendicular (90°) to each other the better it will look.

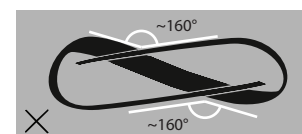
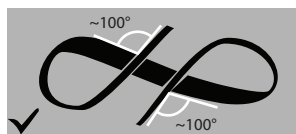

### 3. Simplicity

Less is more. Flourishes are awesome, but you can have too much of a good thing and it makes it look too busy.

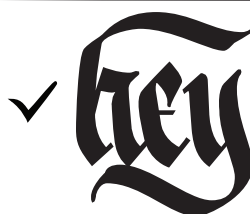

### 4. Symmetry

Try to imagine a bubble around your work like the grey ones to the right. You want to try to keep your bubbles symmetrical horizontally and/or vertically. For each flourish in one direction, try to balance it with another in the opposite direction.

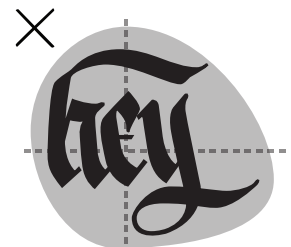
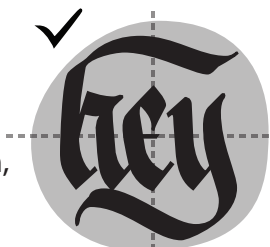

### 5. Creativity

When designing a composition, write the words multiple times in different ways and try to add different abstract flourishes and shapes.



## Composition Practice

Here is an example of a potential composition broken down to the tools you have learned in this workbook. With the tools, guidelines and examples it's up to you to remix and create new things.

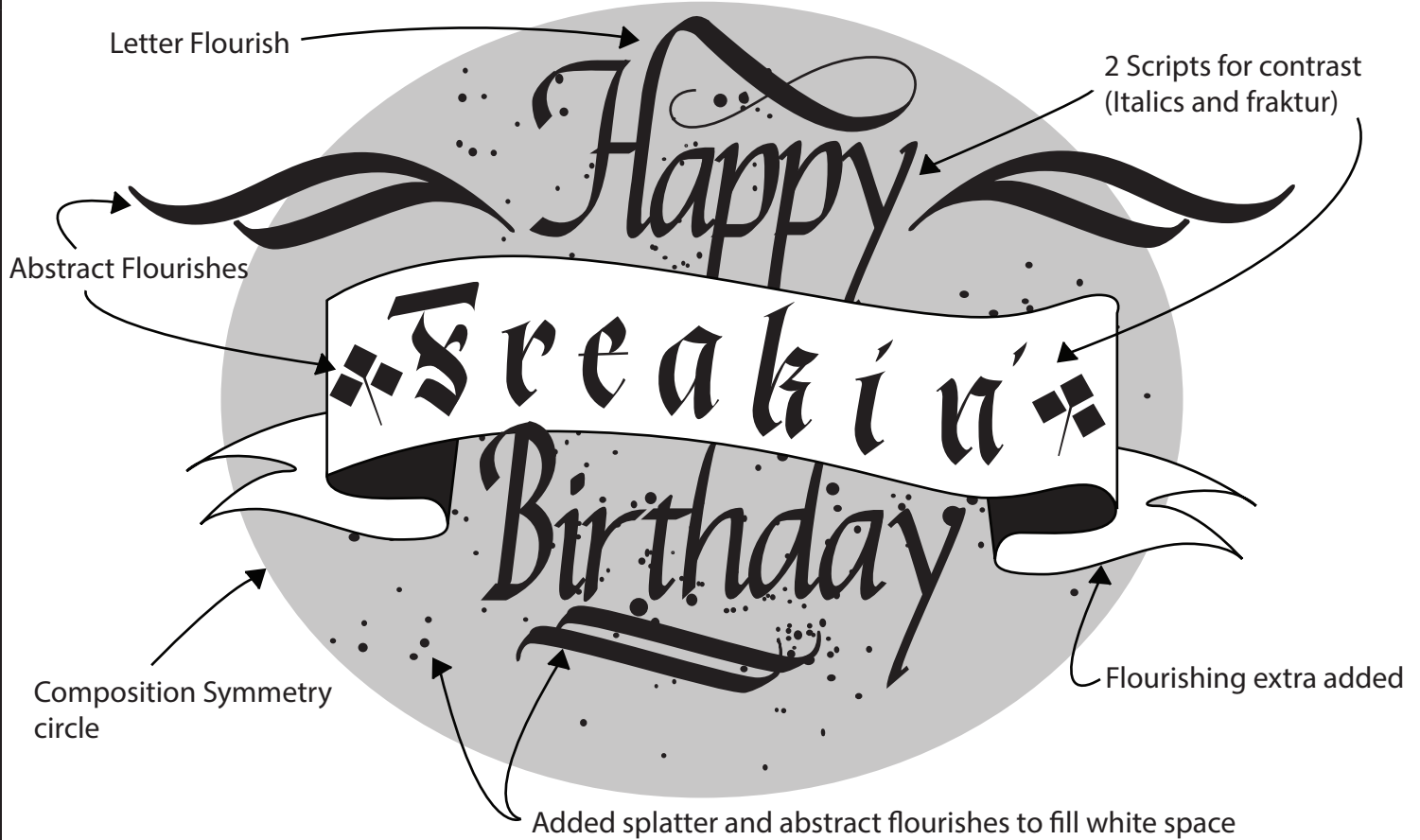

In the space below try sketching and planning out your own composition. Choose a 2-4 word simple quote like "Home Sweet Home" and add flourishes based on the 5 guidelines of flourishing. On the next page, try making your own final copy of your composition using everything you've learned in this workbook.





# Certificate of Excellence

This hereby acknowledges that:

---

Sign Your Name Above

---

HAS SUCCESSFULLY COMPLETED THE  
MASTER  
**ROMAN**  
PRACTICE SHEETS

ON THE DAY OF:

---

Write Date Above

---

Calligrascape



University